

Datasheet Series QL

Model	QL50V50C2	
Order no.	27-036-000-01	
Basic operating modes	CC, CP, CR, CV	
Standard interfaces	RS-232, USB, LAN, CAN	
Voltage range	-50 V ... 50 V	
Current range	-2 A ... 2 A	
Resistance range	1.25 ... 500 Ω	
Power	100 W	
Rise/fall time CC, CV ¹⁾	120 μs	
Bandwidth	3 kHz	
Adjustable int. resistance CC ²⁾	50 Ω ... ∞	
Adjustable int. resistance CV	0 ... 12.5 Ω	
Output terminals rear ³⁾	BPK4-30L	
Power consumption	215 VA	
Mains voltage ⁴⁾	1/N/PE AC 230 V 50 ... 60 Hz	
Mains voltage toggleable	1/N/PE AC 115 V 50 ... 60 Hz	
Noise max. ca. ⁵⁾	65 dB(A)	
Weight ca.	13 kg	
Housing ⁶⁾	19" - 2 U	

1. Rise and fall times are from 10 ... 90 % and 90 ... 10 % of the positive current or voltage setting range in "fast" regulation speed. Tolerance ±20 %. Measured with short-circuited output terminals (current) or with open output terminals (voltage). Other loads may increase rise times. Rise/fall time in "slow" regulation speed: approx. 2 ms.
2. Value is entered as conductance in S.
3. BPK4-30L: Touch-protected binding posts for 4 mm laboratory jacks and stripped wires with diameter up to 4 mm, max. 30 A
BPK4-60L: Touch-protected binding posts for 4 mm laboratory jacks and stripped wires with diameter up to 6 mm, max. 60 A
FKS25/10-SM10: Flat copper bars 25 x 10 mm vertical with hole for screw M10
4. Mains voltage tolerance: ±10 %.
5. Measured on the front from distance of 1 m.
6. 1 U = 44.45 mm.

Operating modes, functions		
Basic operating modes	CC, CP, CR, CV	
Combined operating modes	CC+CV, CV+CC, CP+CV, CR+CV	
Functions	DC source-sink energy storage device test internal resistance measurement list function adjustable internal resistance capacitance simulation function rectangular function (also in PWM mode) modulation (sine, triangle, square, arbitrary) data acquisition (internally or to USB flash drive) save and recall of device settings watchdog in remote operation AC source (only with 4-quadrant models)	
AC source (only 4Q models)	in CC, CV mode (sine, triangular, square, sawtooth, arbitrary) range values are peak values for V and I adjustable offset	
Frequency range ¹⁾	0.1 Hz ... 10 kHz, also mains synchronizable	
User interface	4,3" TFT touch display	
Accuracy of setting DC		
	of setting	of corresponding positive range
Voltage	±0.1 %	±0.05 %
Current	±0.2 %	±0.05 %
Resistance (at V > 5 % of positive voltage range)	±1.4 %	±0.3 % of current range
Power (at V and I > 30 % of corresp. pos. range) (at V and I > 5 % and < 30 % of corresp. pos. range)	±0.35 % ±0.7 %	±0.1 % ±0.25 %
Resolution	15 bits in each quadrant	
Ripple voltage	ca. 0.4 % p-p of positive voltage range	
Ripple current	ca. 0.4 % p-p of positive voltage range	
Accuracy of setting AC (only 4-quadrant models)		
	of setting	of corresponding positive range
Voltage (RMS) ^{1) 2)}	±3 %	±0.25 %
Current (RMS) ^{1) 2)}	±3 %	±0.25 %
Accuracy of adjustable protections		
	of setting	of corresponding positive range
Current protection	±0.2 %	±0.05 %
Voltage protection	±0.1 %	±0.05 %
Resolution	13 bits in each quadrant	
Accuracy of measurement DC		
	of measured value (real value)	of corresponding positive range
Voltage	±0.1 %	±0.05 %
Current	±0.2 %	±0.05 %
Ext. control signal	±0.2 %	±0.1 %
Resistance	is calculated from current and voltage	
Power	is calculated from current and voltage	
Resolution	15 bits in each quadrant	
Sampling time	200 µs, triggerable	
Accuracy of measurement AC		
	of measured value (real value)	of corresponding positive range
Voltage (RMS)	±0.5 %	±0.1 %
Current (RMS)	±0.5 %	±0.1 %
Time constant of RMS measurement	ca. 500 ms	
Accuracy of display		
No. of dec. places	4	
Accuracy	accuracy of measurement DC/AC ±1 digit of display value	

Accuracy of trigger voltage and current	
Trigger voltage	±1 % of positive voltage range
Trigger current	±1 % of positive current range
Sampling time	200 µs
Dynamic function LIST	
Operating modes	CC, CV, CR, CP
No. of settings	max. 300, with corresponding ramp, dwell and sample times
Dwell time ¹⁾	200 µs ... 1,000 s
Ramp time ¹⁾	0 ... 1,000 s
Resolution	200 µs
Accuracy of setting times	±0.02 %
Delay at triggered start	max. 300 µs
Dynamic function rectangular	
Operating modes	CC, CV
No. of levels	2
Pulse times ¹⁾ , resolution	1 µs ... 9,999.999 ms, resolution 1 µs
Accuracy of setting times	±0.02 %
Dynamic function PWM	
Operating modes	CC, CV
No. of levels	2
Frequency ¹⁾ , resolution	0.1 Hz ... 10 kHz, resolution 0.1 Hz
Accuracy of frequency	±0.02 %
Duty cycle, resol.	1 ... 99 %, resolution 1 %
Dynamic function modulation	
Operating modes	CC, CV
Waveforms	Sine, square, triangular, arbitrary (1,024 points)
Frequency ¹⁾ , resol.	0.1 Hz ... 10 kHz, resolution 0.1 Hz
Accuracy of frequency	±0.01 %
Modulation depth	0 ... 100 %
Capacitance simulation function	
Capacitance	10 mF ... 9999.99 F
Data acquisition	
to external USB flash drive	
Sampling time	0.1 ... 30.0 s, resolution 0.1 s
Measurement data	timestamp, voltage, current
No. of measurement points	limited by flash drive memory capacity
File format	.csv
to internal memory	
Sampling time	200 µs ... 1,000 s, resolution 200 µs, synchronized with dynamic function
Measurement data	timestamp, voltage, current
No. of meas. points	max. 40,000
Settings memory	
No. of memory positions	9, selectable (incl. programmed list) 1 for last device settings at power-off or power failure
I/O port: inputs and outputs	
Inputs	analog setting I and V with -5 ... 0 ... 5 V or -10 ... 0 ... 10 V analog protection setting I or V with -10 ... 0 ... 10 V output activation operating mode CC/CV control speed selection slow/fast remote shut-down readable digital input (by SCPI command) trigger input control input (activates I/O port)

The specified accuracies refer to an ambient temperature of 23 ±5 °C. The specified accuracies are valid when the sense lines are connected. At voltages with higher disturbance values the accuracy can change for the worse.

1. The applicable time or frequency range is limited by the bandwidth of the respective device.
2. at 50 ... 60 Hz
3. only -10 V ... 0 ... 10 V
4. positive/negative DC voltage or RMS value of a sinusoidal AC voltage

Technical Data

Digital input level	logical low: 0 ... 0.8 V, logical high: 3 ... 30 V
Outputs	analog voltage monitor output -10 ... 0 ... 10 V analog current monitor output -10 ... 0 ... 10 V output activation state status output for upper protection value V or I status output for lower protection value V or I trigger output
Digital output level	logical low: 0 ... 0.8 V logical high: 5 V/24 V selectable, max. 10 mA (push-pull)

I/O port: accuracy of analog control -5 ... 0 ... 5 V or -10 ... 0 ... 10 V

	of setting	of corresponding positive range
Voltage	±0.2 %	±0.1 %
Current	±0.2 %	±0.1 %
Resistance (at V > 5 % of positive voltage range)	±1.6 %	±0.4 % of current range
Power (at V and I > 30 % of corresp. pos. range) (at V and I > 5 % and < 30 % of corresp. pos. range)	±0.55 % ±0.9 %	±0.2 % ±0.35 %
Current protection ³⁾	±1 %	±0.4 %
Voltage protection ³⁾	±1 %	±0.4 %
	input resistance of analog inputs >10 kΩ	

I/O port: accuracy of analog monitor outputs -10 ... 0 ... 10 V

	of analog signal of actual value	offset voltage
Voltage	±0.2 %	±15 mV
Current	±0.2 %	±15 mV
	permissible load > 2 kΩ	

I/O port: permissible voltages

	standard I/O port	isolated I/O port (option QL06)
Vout-io (GND - neg. output)	max. 2 V ⁴⁾	max. 125 V ⁴⁾
VioPE (GND - PE)	max. 125 V ⁴⁾	max. 125 V ⁴⁾

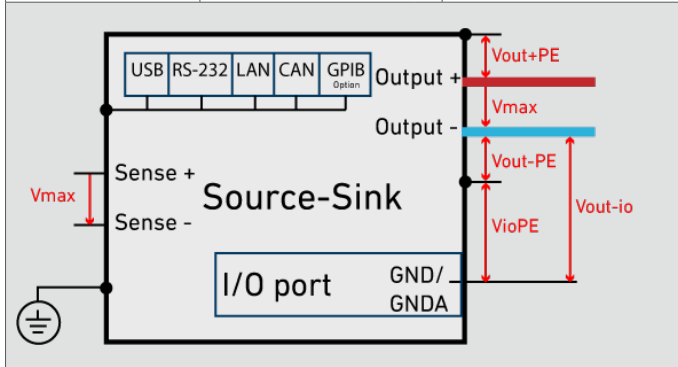

Output

Output resistance	>50 kΩ when output is off
Max. output voltage Vmax	see model overview
Min. output voltage Vmin	see model overview

Output: permissible voltages

	standard I/O port	isolated I/O port (option QL06)
Vout-PE (neg. output - PE)	max. 125 V ⁴⁾	max. 125 V ⁴⁾
Vout+PE (pos. output - PE)	Vmax + max. 125 V ⁴⁾	Vmax + max. 125 V ⁴⁾

Power

Nominal power	see model overview (at Ta = 21 °C)
Derating	-1.2 %/°C for Ta > 21 °C

Protection and monitoring	
Protective devices	overcurrent overtemperature
Monitoring	overvoltage indication
Terminals	
Output	see model overview
Sense	PH4/3.5-ST8, see starting at page 123
Operating conditions	
Operating temperature	5 ... 40 °C
Stock temperature	-25 ... 65 °C
Max. operating height	2,000 m above sea level
Pollution degree	2
Overvoltage category of mains	II
Max. humidity	80 % at 31 °C, linear decreasing to 50 % at 40 °C
Min. distance rear panel to wall or other objects	70 cm
Cooling	temperature-controlled air cooling
Noise, weight	see model overview
Mains voltage	see model overview
Mains cable	length max. 3 m cross-section of mains leads min. 1 mm ²
Power consumption	see model overview

Housing	
Size	see model overview
Color front rear top, side panels	RAL7035 (light grey) stainless steel RAL7037 (dusty grey)

Safety and EMC	
Protection class	1
Measuring category	O (CAT I according to EN 61010:2004)
Electrical safety	DIN EN 61010-1 DIN EN 61010-2-030
EMC	DIN EN 61326-1 DIN EN 55011 DIN EN 61000-3-2 DIN EN 61000-3-3

Standard interfaces	
Data interfaces	RS-232, USB, LAN, CAN
I/O port	standard (not isolated)

Available options	
Data interface QL02	GPIB
Hardware extensions QL06 QL14	galvanically isolated I/O port heavy-weight castors for models from 5 U

Calibration, warranty	
FCC-QLxx	Factory Calibration Certificate, twice for free after registration
Recommended calibration interval	2 years
Warranty	2 years

Technical data of production series B, rev. 6. Subject to technical changes without notice.

The specified accuracies refer to an ambient temperature of 23 ±5 °C. The specified accuracies are valid when the sense lines are connected. At voltages with higher disturbance values the accuracy can change for the worse.

- The applicable time or frequency range is limited by the bandwidth of the respective device.
- at 50 ... 60 Hz
- only -10 V ... 0 ... 10 V
- positive/negative DC voltage or RMS value of a sinusoidal AC voltage